

# PalmModem<sup>®</sup> Connectivity Kit Handbook

## **Copyright**

Copyright © 1997-2001 Palm, Inc. or its subsidiaries. All rights reserved. HotSync, Palm OS, and PalmModem are registered trademarks of Palm, Inc. or its subsidiaries. The HotSync logo, Palm, and the Palm logo are trademarks of Palm, Inc. or its subsidiaries. Other product and brand names may be trademarks or registered trademarks of their respective owners.

## **Disclaimer**

Palm, Inc. and its subsidiaries assume no responsibility for any damage or loss resulting from the use of this handbook.

Palm, Inc. and its subsidiaries assume no responsibility for any loss or claims by third parties which may arise through the use of this product. Palm, Inc. and its subsidiaries assume no responsibility for any damage or loss caused by deletion of data as a result of malfunction, dead battery, or repairs. Be sure to make backup copies of all important data on other media to protect against data loss.

P/N: 406-3157-01  
A/N: 423-3157-01

# Contents

<b>Chapter 1: Introduction .....</b>	<b>1</b>
What can I do with my PalmModem connectivity kit? .....	2
<b>Chapter 2: Setting Up Your PalmModem®</b>	
<b>Connectivity Kit.....</b>	<b>5</b>
Installing the batteries .....	5
Replacing batteries.....	5
Configuring your computer.....	6
Configuring your handheld.....	7
Selecting conduits for a modem HotSync operation .....	11
Installing applications on your handheld.....	12
<b>Chapter 3: Using Your PalmModem® Connectivity Kit ....</b>	<b>15</b>
Attaching PalmModem connectivity kit and cables .....	15
Performing a remote HotSync operation.....	16
Detaching your PalmModem connectivity kit.....	17
<b>Product Regulatory Information.....</b>	<b>19</b>



# Chapter 1

## Introduction

Your PalmModem® connectivity kit enables you to use your handheld to send and receive data at your convenience. You don't have to connect your handheld directly to your computer or laptop to update your data.

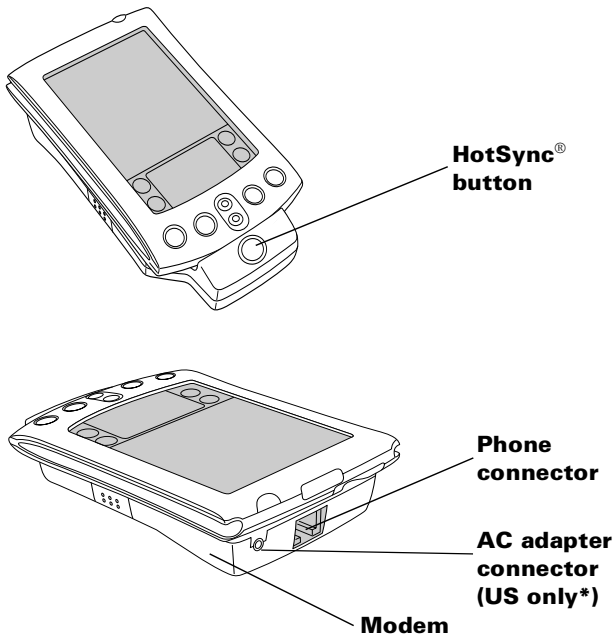

\*Use only UL listed PalmModem AC adapter #10202U with an input of +3V/250mA or the equivalent UL listed adapter.

# What can I do with my PalmModem connectivity kit?

From remote locations, with your modem and handheld you can:

- Send and receive e-mail using an Internet Service Provider.
- Synchronize your data with one touch using any of the following:
  - Palm™ Desktop organizer software via a PC modem using HotSync® technology, or via your company's remote access server (RAS) using network HotSync technology and TCP/IP.
  - Server-based applications (such as corporate e-mail, phone book, expense, and intranet web pages) via your company's RAS using Palm HotSync® Server software (go to the web site <http://www.palm.com> for more information).
  - Third-party personal information managers (PIMs), such as Lotus Organizer, Symantec ACT, and Microsoft Outlook using HotSync technology (third-party software required).
- Use web clipping applications installed on your handheld to quickly and simply retrieve information from the Internet.

To increase your productivity, software applications have been bundled with your modem.

Contact the vendors below for more information about some of the software applications you can use with your handheld and modem.

<b>Use</b>	<b>Application</b>	<b>Description</b>	<b>Vendor</b>
E-mail	Network HotSync	Supports remote access to your e-mail and Palm™ Desktop software using either your company's existing LAN or dial-in (RAS) server	Palm, Inc. <a href="http://www.palm.com">www.palm.com</a>
	MultiMail®Pro and MultiMail® SE	Supports SMTP, POP3, and IMAP4 protocols	Palm, Inc. <a href="http://www.palm.com">www.palm.com</a>
	AOL Mail	Supports AOL e-mail	America Online, Inc. <a href="http://www.aol.com/anywhere">www.aol.com/anywhere</a>
	One Touch	Supports SMTP and POP3 e-mail protocols	JP Systems <a href="http://www.jpsystems.com">www.jpsystems.com</a>
	Palmeta Mail	Supports Netscape Mail or any MAPI e-mail system	Palmeta Software <a href="http://www.palmeta.com">www.palmeta.com</a>

<b>Remote synchronization</b>	Desktop To Go	Supports Microsoft Outlook	DataViz <a href="http://www.dataviz.com">www.dataviz.com</a>
	EasySync for Lotus Notes	Supports Lotus Notes	Lotus <a href="http://www.lotus.com">www.lotus.com</a>
	EasySync for Lotus Organizer	Supports Lotus Organizer	Lotus <a href="http://www.lotus.com">www.lotus.com</a>
	Intellisync	Supports Microsoft Outlook, Symantec ACT, GoldMine, Lotus Notes, Lotus Organizer, and Meeting Maker	Tele-Support Software <a href="http://www.pumatech.com">www.pumatech.com</a>
	Now Synchronize	Supports Now Up-to-Date	Power On Software <a href="http://www.poweronsoftware.com">www.poweronsoftware.com</a>
	PocketMirror	Supports Microsoft Outlook	Chapura, Inc. <a href="http://www.chapura.com">www.chapura.com</a>
<b>Internet access</b>	Web Clipping	Supports retrieving information from the Internet	Palm, Inc. <a href="http://www.palm.com">www.palm.com</a>



# Chapter 2

## Setting Up Your PalmModem® Connectivity Kit

Before you use your PalmModem® connectivity kit, you must:

- Install the batteries
- Configure your computer
- Configure your handheld

You might also want to install applications, such as e-mail, on your handheld.

### Installing the batteries

To use your modem, you must first install two AAA alkaline batteries. The batteries fit in the compartment behind the battery door on the back of the modem. Make sure to click the door into place after installing the batteries.

**Note:** A diagram in the interior of the battery compartment shows the orientation of the positive (+) and negative (-) ends of the batteries. When correctly installed, the clips in the battery compartment secure the batteries in place.

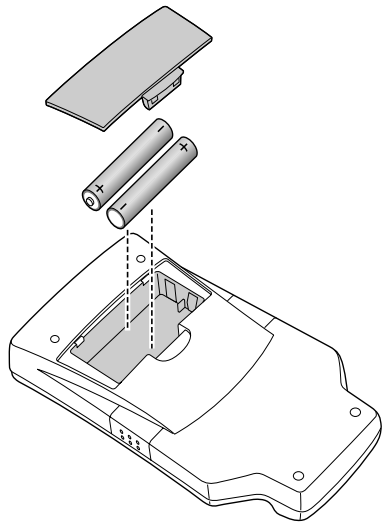

### Replacing batteries

Under normal conditions, the AAA batteries provide approximately two and a half hours of continuous use. When your modem has approximately 15% of battery life remaining it will sound three short beeps, which repeat every five minutes until the batteries are drained. Replace the batteries as soon as possible.

## Configuring your computer

**Important:** You do not need to configure your computer to connect to your ISP and download mail. If this is the only operation you want to perform with your modem, skip to “Configuring your handheld” later in this chapter.

To use your modem to perform remote operations with your desktop computer, you must first complete the following steps:

- Make sure Palm™ Desktop organizer software settings are correct
- Leave your computer running and ready to receive a call

A network HotSync® operation requires the following (consult your System Administrator for assistance):

- Your computer has TCP/IP support installed.
- Both your company’s network system and its remote access server support TCP/IP.
- You have a remote access account.
- Your computer has Palm Desktop software version 4.0 or later installed.

Everything you need to connect to your company’s dial-in server (network modem) is included with Palm Desktop software version 4.0 or later and your Palm OS handheld software version 4.0 or later. You need to activate the feature, however, on both Palm Desktop software and your handheld.

### **To set up your Windows computer for a remote HotSync operation:**

1. Click the HotSync Manager icon  in the system tray (bottom-right corner of the taskbar) to open the HotSync Manager menu.
2. In the HotSync Manager menu, make sure Modem is checked.  
Or, if you want to synchronize using the network HotSync application, make sure Network is checked, and then skip to “Configuring your handheld” later in this chapter.
3. From the HotSync Manager menu, choose Setup.
4. Click the Modem tab and adjust the options as needed. See “Conducting a HotSync operation via modem” in your handheld handbook for additional information.
5. Click OK.



### To set up your Macintosh for a remote HotSync operation:

1. Click the HotSync Manager icon  from the Instant Palm Desktop menu (upper-right corner of your screen).
2. From the HotSync menu, select HotSync Setup, and on the Serial Port Settings tab make sure Modem is checked.
3. Adjust the Modem Setup options as needed.
4. From the File menu, choose Quit.

## Configuring your handheld

Before you use your PalmModem connectivity kit, you must configure your handheld to communicate with it.

### To prepare your handheld for a modem HotSync operation:

1. Tap the Applications icon .
2. Tap the HotSync icon .
3. Tap Modem.

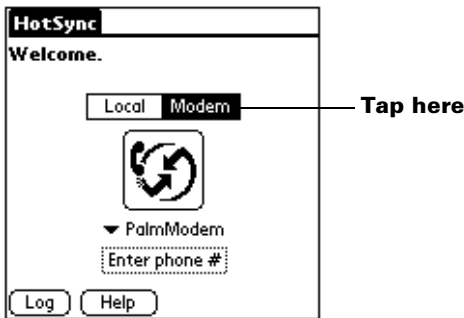

4. Tap the pick list below the icon and select a modem configuration.

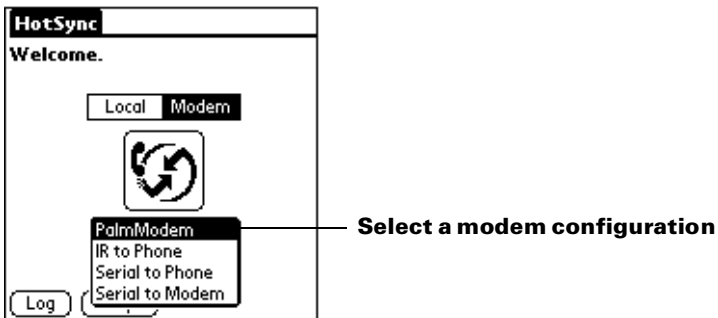

5. Tap the Enter phone # box.

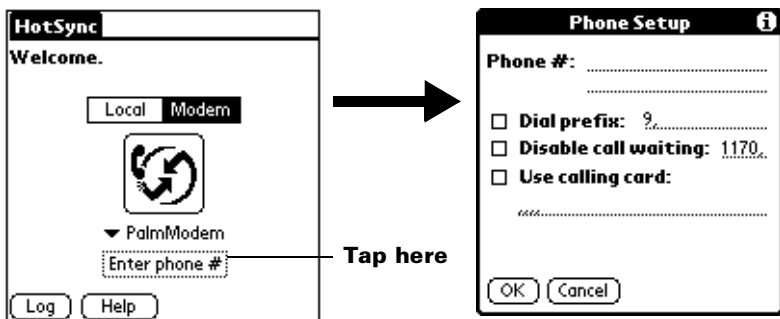



**Note:** If you plan to connect to your company's dial-in server (network modem) instead of a computer modem, see "To prepare your handheld for a network HotSync operation:" later in this chapter.

6. Enter the telephone number to access the modem connected to your computer.
7. If needed, enter a dial prefix (such as "9") to access an outside line, and then tap the Dial Prefix check box.

**Tip:** To add a "pause" in the dialing sequence, enter a comma in the field. Each comma equals a two second pause.

8. If the phone line you're using for the handheld has Call Waiting, select the Disable call waiting check box to avoid an interruption during the modem HotSync operation.
9. If you want to use a calling card to place the call, select the check box and enter the calling card number.
10. Tap OK.

**To select Connection Preferences for a modem HotSync operation:**

1. Tap the Applications icon .
2. Tap the Preferences icon .
3. Tap the pick list in the upper-right corner and select Connection.
4. Tap the configuration you want to use.



5. Tap Edit.



6. Tap the Connect to pick list and select Modem.

7. Tap the Via pick list and select Cradle/Cable.

8. Adjust the other options as needed.

**Dialing** Select the Rotary setting only if you are certain that your telephone service does not support TouchTone dialing.

**Note:** When dialing from Europe, the modem supports TouchTone dialing only. Rotary and pulse dialing are not supported in Europe.

**Volume** Controls the modem speaker volume.



## Details

Provides access to the following optional settings:

- **Speed.** Determines the modem speed for downloading data.
- **Country.** Determines the country settings that are used.
- **Flow Ctl.** Regulates the data sent to your modem. If your modem receives more data than its buffer can hold, the modem uses flow control to temporarily stop data transmission.
- **Init String.** This field is used for standard AT commands that enable the modem to perform special functions.

9. Tap OK to save the settings.

### To prepare your handheld for a network HotSync operation:

1. Tap the Applications icon .
2. Tap the HotSync icon .
3. Tap the Menu icon .
4. Tap Options, then tap Modem Sync Prefs.
5. Tap Network.

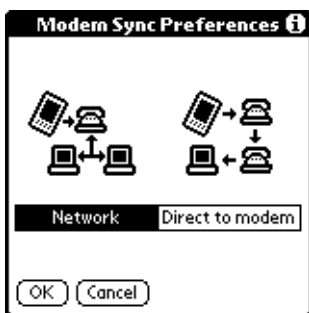

6. Tap OK.
7. Tap Select Service.

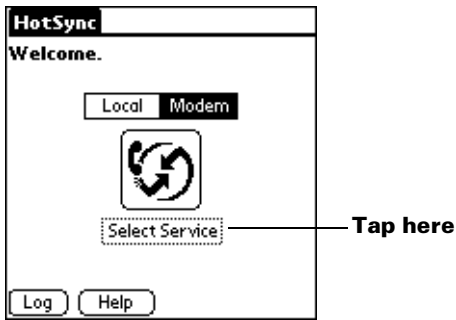

**Note:** See “Network preferences and TCP/IP software” in your handheld handbook for information on creating a network connection.

8. Tap Service and select a service.

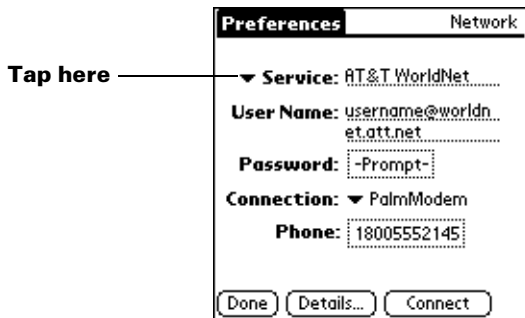



9. Tap Done.

**Note:** Before performing a network HotSync operation, you must enable the network HotSync technology and perform a local HotSync operation. Contact your System Administrator to set up the network HotSync technology, and for additional information, go to this web site: <http://www.palm.com>.

## Selecting conduits for a modem HotSync operation

The Conduit Setup dialog box on your handheld enables you to define which files and/or applications synchronize during a modem HotSync operation. You can use these settings to minimize the time required to synchronize data with a modem.

### To change conduits for a modem HotSync operation:

1. Tap the Applications icon .
2. Tap the HotSync icon .
3. Tap the Menu icon .
4. Tap Options, and then tap Conduit Setup.
5. Tap the check boxes to deselect the files and applications that you do *not* want to synchronize during a modem HotSync operation. The default setting is to synchronize all files.



**Note:** Applications that do not have a database (such as games) do not synchronize — even if you select the item in the Conduit Setup dialog box.

6. Tap OK.

## Installing applications on your handheld

Before you install any applications, such as e-mail, on your handheld, it's a good idea to perform a HotSync operation to back up your data.

### To install an application from a Windows computer:

1. Insert the CD-ROM into the CD-ROM drive.

**Note:** If installation does not begin, click the Windows Start button, choose Run, enter D:/autorun.exe, and then click OK. If necessary, replace D: with the drive letter assigned to your CD-ROM drive.

2. If prompted, choose a language.
3. From the CD menu, choose the application you want to install.

4. Click Install.
5. Perform a HotSync operation to install the application on your handheld.

**To install an application from a Macintosh:**

1. Insert the CD-ROM into the CD-ROM drive and double-click the CD folder on your desktop.
2. Double-click the folder for the application you want to use.
3. Double-click the HotSync Manager icon in the Palm folder.
4. Choose Install Handheld Files from the HotSync menu.
5. Drag the PRC file from the CD-ROM to the Install Handheld Files window.
6. Perform a HotSync operation to install the application on your handheld.



# Chapter 3

## Using Your PalmModem® Connectivity Kit

After you prepare your computer and your handheld, and select your Conduit Setup options, you are ready to perform a modem or network HotSync® operation.

Now when you leave the office, you can use your PalmModem® connectivity kit and your handheld to stay connected with your computer or network.

### Attaching PalmModem connectivity kit and cables

Your modem has a 16-pin connector that slides into the grooves on your handheld's universal connector. Make sure your modem snaps into place on the handheld. Use a standard RJ11 cable to connect to an analog phone line.

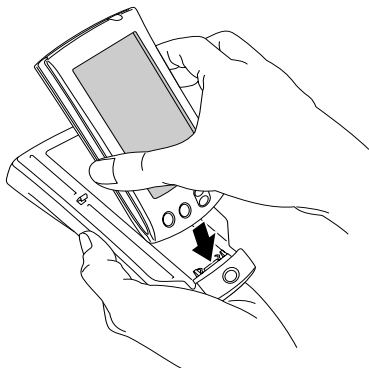

**Slide into connector**

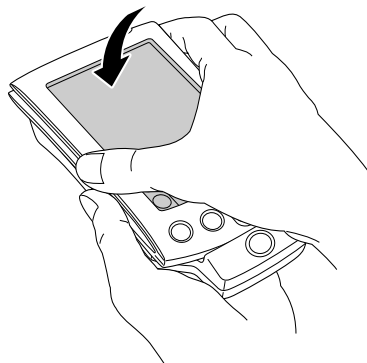

**Snap into place**

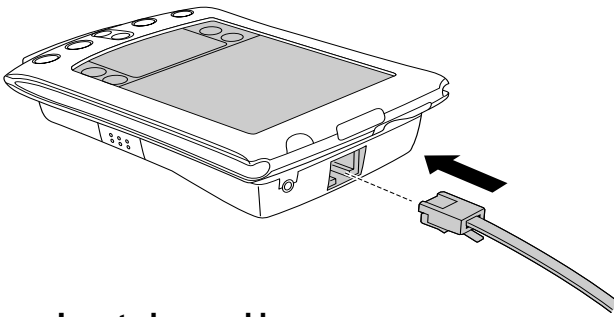

### **Insert phone cable**

**Note:** It is important to use a standard analog phone line, such as those used in homes. If you use your modem in an office or hotel, make sure it is connected to a phone line with a data port, a fax line, or a modem line. If you accidentally use a digital phone line, your modem will respond as though there is no dial tone.

## **Performing a remote HotSync operation**

After you connect your modem to your handheld, you can use your modem to perform remote HotSync operations by dialing your PC modem or network server.

**Important:** Remember to leave your computer running so you can perform remote operations.

### **To perform a modem or network HotSync operation:**

- Press the HotSync button on the front of your modem to initiate remote HotSync operations.

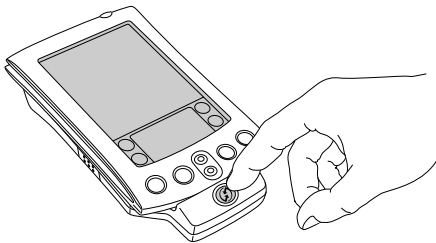

If you have any problems conducting a successful HotSync operation, see “Frequently Asked Questions” in your handheld handbook.

## Detaching your PalmModem connectivity kit

After you complete your modem operations, press the buttons on both sides of the modem, then rotate the handheld away from the modem.

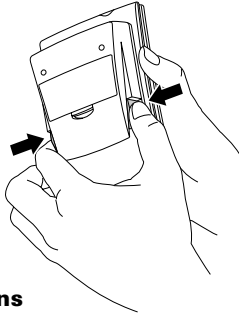

**Press buttons**

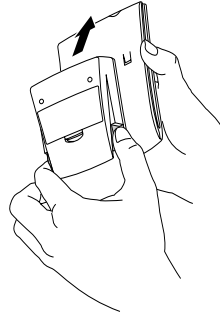

**Pull handheld  
from modem**



# Product Regulatory Information

## FCC-15

This device complies with Part 15 of the FCC rules. Operation is subject to the following two conditions: 1.This device may not cause harmful interference, and 2.This device must accept any interference received, including interference that may cause undesired operation.

**Note:** This equipment has been tested and found to comply with the limits for a Class B digital device, pursuant to Part 15 of the FCC Rules. These limits are designed to provide reasonable protection against harmful interference in a residential installation. This equipment generates, uses, and can radiate radio frequency energy and, if not installed and used in accordance with the instructions, may cause harmful interference to radio communications. However, there is no guarantee that interference will not occur in a particular installation. If this equipment does cause harmful interference to radio or television reception, which can be determined by turning the equipment off and on, the user is encouraged to try to correct the interference by one or more of the following measures:

- Reorient or relocate the receiving antenna.
- Increase the separation between the equipment and receiver.
- Connect the equipment into an outlet on a circuit different from that to which the receiver is connected.
- Consult the dealer or an experienced radio/TV technician for help.

The use of shielded I/O cables is required when connecting this equipment to any and all optional peripheral or host devices. Failure to do so may violate FCC rules.

**Caution:** Changes or modifications not covered in this manual must be approved in writing by the manufacturer's Regulatory Engineering Department. Changes or modifications made without prior written approval may void the user's authority to operate this equipment.

**Responsible Party:**  
Geoffrey Lin  
8400 NW 25th Street, Suite 110  
Miami, FA 33162  
United States of America  
(305) 468-9250

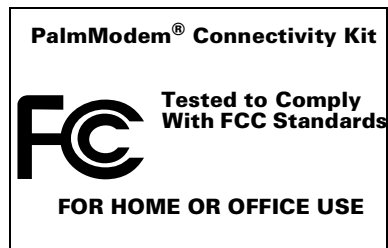

# Canadian ICES-003 Statement

This Class B digital apparatus meets all requirements of the Canadian Interference-Causing Equipment Regulations.

Cet appareil numérique de la classe B respecte toutes les exigences du Règlement sur le matériel brouilleur du Canada.

## FCC-68

This equipment complies with Part 68 of the FCC rules. A label is affixed to the equipment that contains, among other things, the FCC registration number, USOC and Ringer Equivalency Number (REN) for this equipment. If these numbers are requested, provide this information to your telephone company.

The REN is useful to determine the quantity of devices you may connect to your telephone line and still have those devices ring when your number is called. In most, but not all areas, the sum of the RENs of all devices should not exceed five (5.0). To be certain of the number of devices you may connect to your line, as determined by the REN, you should call your local telephone company to determine the maximum REN for your calling area.

If the equipment causes harm to the telephone network, the telephone company may discontinue your service temporarily. If possible, they will notify you in advance; if advance notice is not practical, you will be notified as soon as possible. You will be advised of your right to file a complaint with the FCC.

Your telephone company may make changes in its facilities, equipment, operations, or procedures that could affect the proper operation of your equipment. If they do, you will be given advance notice to give you an opportunity to maintain uninterrupted service.

If you experience trouble with this product, contact your Authorized Reseller, or call Palm, Inc. at (408) 326-9000. You may be required to present proof of purchase.

The telephone company may ask you to disconnect the equipment from the network until the problem has been corrected, or until you are sure the equipment is not malfunctioning.

No customer repairs are possible to the equipment. If you experience trouble with the equipment, contact your Authorized Reseller.

This equipment may not be used on coin service provided by the telephone company. Connection to party lines is subject to state tariffs. Contact your state public utility commission or corporation commission for information.

When ordering network interface (NI) service from the local Exchange Carrier, specify service arrangement USOC RJ11C.

**FAX Branding:** This device complies with the FAX branding requirements of the Telephone Consumer Protection Act of 1991. Please refer to the fax modem software manual for instructions on how to program this device.

## Industry Canada (CS-03)

The Canadian Department of Communications label identifies certified equipment. This certification means that the equipment meets certain telecommunications network protective, operational, and safety requirements. The Department does not guarantee the equipment will operate to the user's satisfaction.

Before installing this equipment, users should ensure that it is permissible to be connected to the facilities of the local telecommunications company. The equipment must also be installed using an acceptable method of connection. In some cases, the company's inside wiring associated with a single line individual service may be extended by means of a certified connector assembly (telephone extension cord). The customer should be aware that compliance with the above conditions may not prevent degradation of service in some situations.

Repairs to certified equipment should be made by an authorized Canadian maintenance facility designated by the supplier. Any repairs or alterations made by the user to this equipment, or equipment malfunctions, may give the telecommunications company cause to request the user to disconnect the equipment.

Users should ensure for their own protection that the electrical ground connections of the power utility, telephone lines, and internal metallic water pipe system, if present, are connected together. This precaution may be particularly important in rural areas.

**CAUTION:** Users should not attempt to make such connections themselves, but should contact the appropriate electric inspection authority, or electrician, as appropriate.

**NOTICE:** The LOAD NUMBER (LN) assigned to each terminal device denotes the percentage of the total load to be connected to a telephone loop which is used by the device, to prevent overloading. The termination on a loop may consist of any combination of devices subject only to the requirement that the sum of the LOAD NUMBERS of all the devices does not exceed 100.

The telephone connector to be used for this equipment is an RJ11/CA11A.



## CE Mark Declaration of Conformity

This modem is designed to be compatible with the European PSTN networks, and is in conformity with the following European Union Directives:

- R&TTE Directive 1999/5/EC
- Low Voltage Directive 73/23/EEC
- EMC Directive 89/336/EEC



This is a Class B product based on the standard of the Voluntary Control Council for Interference from Information Technology Equipment (VCCI). If this is used near a radio or television receiver in a domestic environment, it may cause radio interference. Install and use the equipment according to the instruction manual.

この装置は、情報処理装置等電波障害自主規制協議会（VCCI）の基準に基づくクラスB情報技術装置です。この装置は、家庭環境で使用することを目的としていますが、この装置がラジオやテレビジョン受信機に近接して使用されると、受信障害を引き起こすことがあります。

取扱説明書に従って正しい取り扱いをして下さい。